

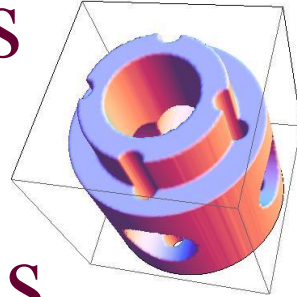

Robust Volume Calculations for CSG Components in MC Transport Calculations

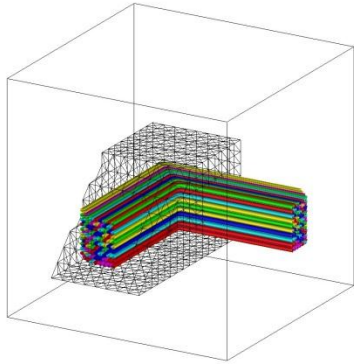

David L. Millman

Bettis Atomic Power Laboratory

In collaboration with

Brian R. Nease, David P. Griesheimer, and Jack Snoeyink

21 February 2013

Motivation/Background

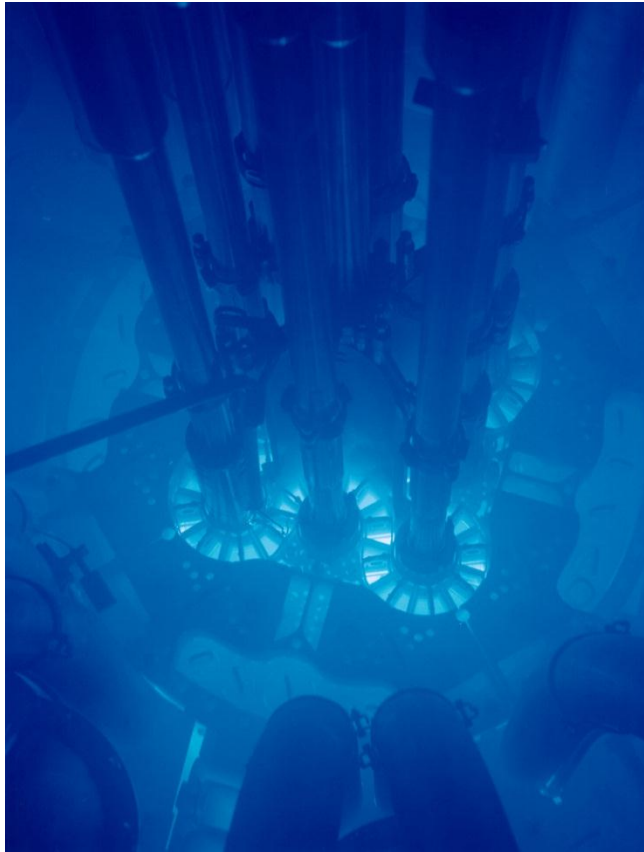
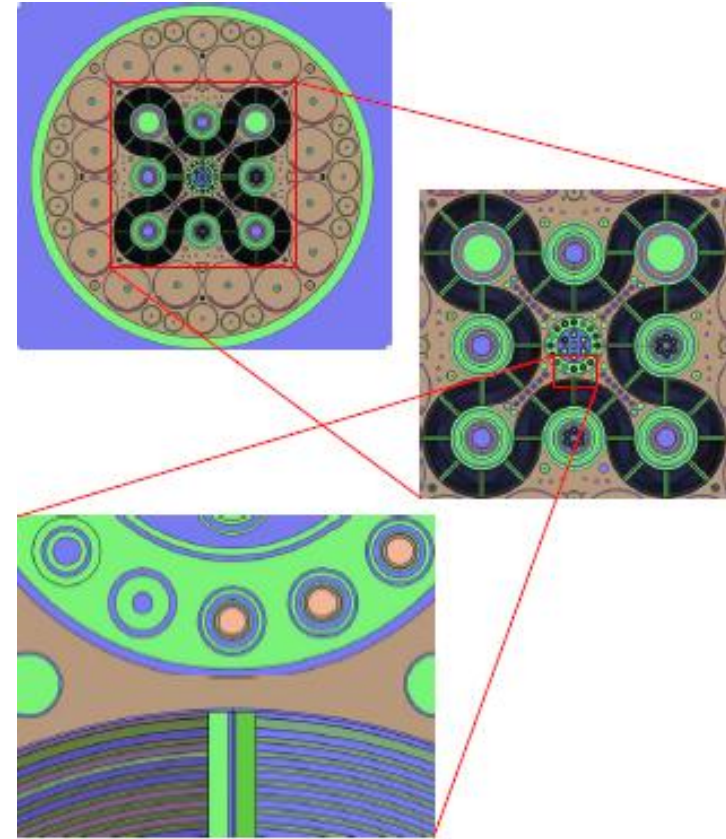

Image from Idaho National Lab, Flickr



T.M. Sutton, et. al., *The MC21 Monte Carlo Transport Code*, Proceedings of the Joint International Topical Meeting on Mathematics & Computation and Supercomputing in Nuclear Applications (M&C + SNA 2007), Monterey, CA (2007)

Motivation/Background

- Constructive solid geometry (CSG) is commonly used to define geometric objects in Monte Carlo transport calculations
 - CSG allows for exact representation of objects bounded surfaces (typically up to 2nd order)
 - CSG representations allow nearly unlimited flexibility for creating complex models for
 - Criticality analysis
 - Reactor analysis

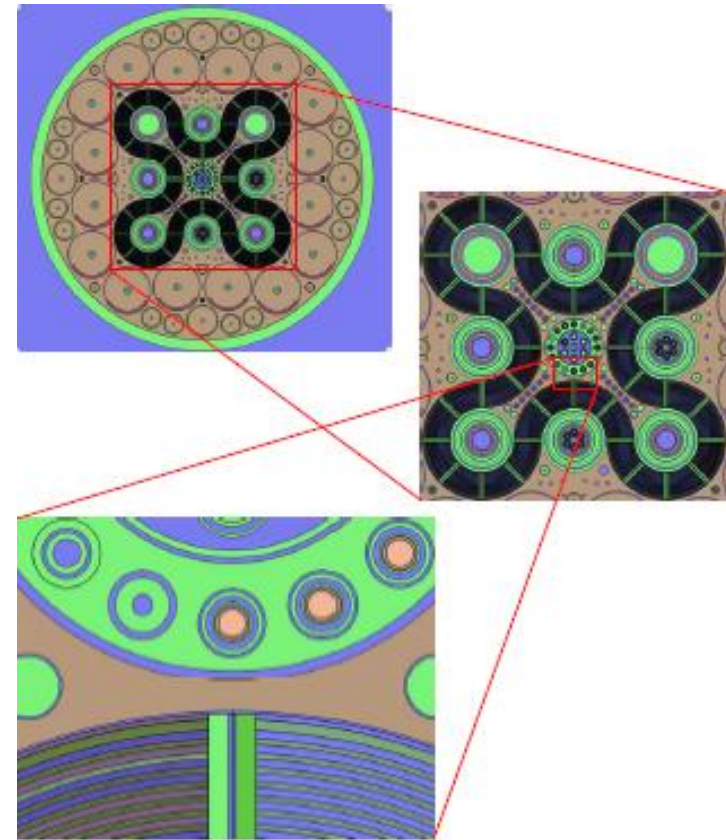

Motivation/Background

- Unfortunately, calculating volumes of CSG components is non-trivial.
 - This does not affect the calculation of volume integrated quantities...
 - but, volume information is needed for calculating flux and reaction rate densities.
- Today, volume calculation algorithms for CSG models are limited
 - Analytical methods (limited)
 - Stochastic methods (slow/noisy)

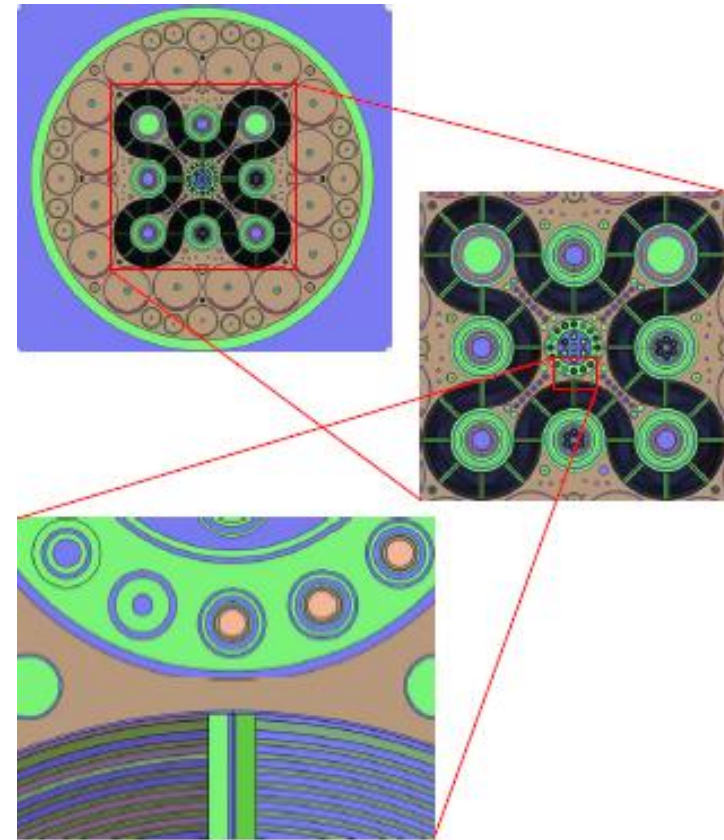

Motivation/Background

- Unfortunately, calculating volumes of CSG components is non-trivial.
 - This does not affect the calculation of volume integrated quantities...
 - but, volume information is needed for calculating flux and reaction rate densities.
- Today, volume calculation algorithms for CSG models are limited
 - Analytical methods (limited)
 - Stochastic methods (slow/noisy)

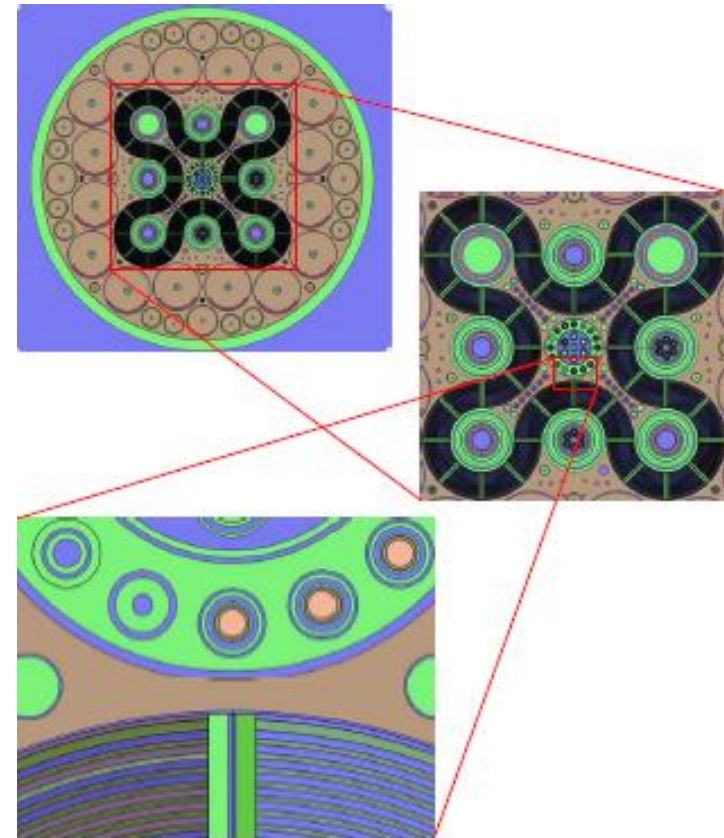

Why is this a hard problem?

T.M. Sutton, et. al., *The MC21 Monte Carlo Transport Code*, Proceedings of the Joint International Topical Meeting on Mathematics & Computation and Supercomputing in Nuclear Applications (M&C + SNA 2007), Monterey, CA (2007)

Calculus Problem 1

Let D be the region left after drilling a radius r hole through the center of a radius R sphere.

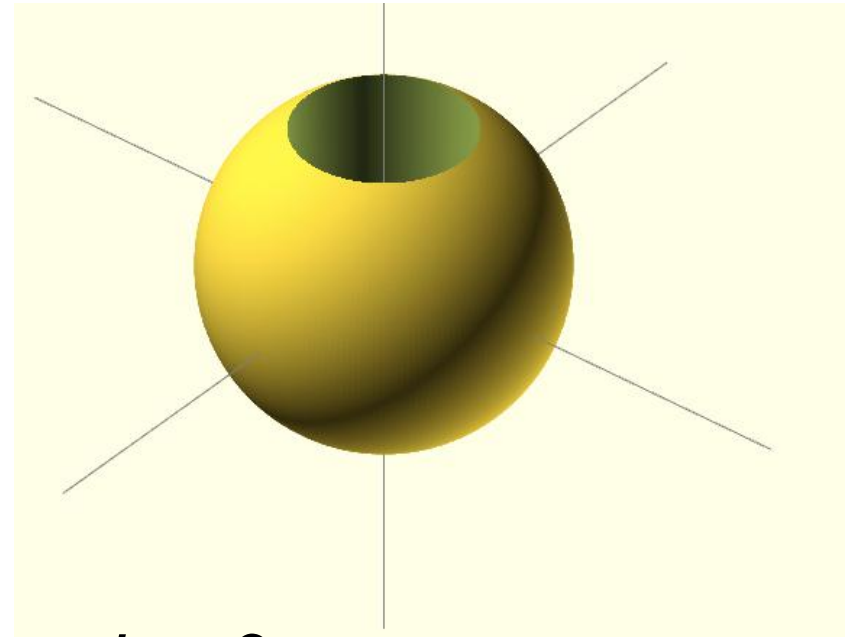

What is the volume of *domain D*?



$$\iiint_D 1 dV$$

Calculus Problem 1

Let D be the region left after drilling a radius r hole through the center of a radius R sphere.

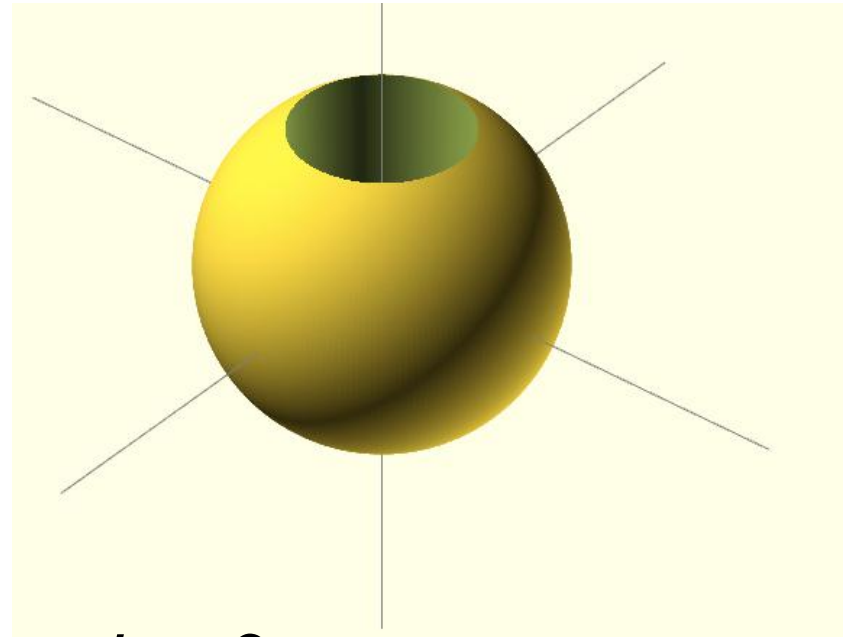

What is the volume of *domain D*?



$$\iiint_D 1 dV = \frac{4}{3} (R^2 - r^2)^{\frac{3}{2}}$$

Calculus Problem 2

Let D be the intersection of 10 quadratics:

$$\begin{aligned} 0 &> 0.74742x^2 + 0.93022y^2 + 0.32256z^2 + 0.26590xy + -0.82750xz + 0.43517yz + 2.47974x + 26.97936y + 7.15111z + 171.27254 \\ 0 &> 0.00487x^2 + 0.00638y^2 + 0.00212z^2 + 0.00181xy + -0.00537xz + 0.00299yz + 0.51989x + -0.07938y + 0.87196z + 36.54138 \\ 0 &< -0.00469x^2 + 0.00617y^2 + -0.00134z^2 + 0.00116xy + 0.00609xz + 0.00326yz + 0.52845x + -0.08488y + 0.86497z + -11.92745 \\ 0 &> 0.00180x^2 + 0.00647y^2 + 0.00497z^2 + -0.00039xy + 0.00597xz + 0.00003yz + 0.59729x + -0.12904y + 0.98774z + 37.27755 \\ 0 &> 0.00173x^2 + 0.00681y^2 + 0.00479z^2 + -0.00022xy + 0.00574xz + 0.00034yz + -0.76442x + 0.12037y + 0.67647z + 27.71845 \\ 0 &> 0.00180x^2 + 0.00657y^2 + 0.00498z^2 + -0.00037xy + 0.00599xz + 0.00008yz + -0.76185x + 0.11119y + 0.68028z + 27.63880 \\ 0 &< -0.00156x^2 + 0.00591y^2 + -0.00403z^2 + 0.00324xy + -0.00503xz + 0.00601yz + -0.90629x + 0.19555y + 0.44420z + -24.48200 \\ 0 &> 0.00643x^2 + 0.00046y^2 + 0.00614z^2 + -0.00143xy + -0.00036xz + -0.00301yz + -0.04751x + -1.00153y + -0.12108z + 11.02481 \\ 0 &> 0.00323x^2 + -0.00046y^2 + -0.00276z^2 + 0.00209xy + -0.01145xz + 0.00273yz + -0.19156x + -0.92584y + -0.35667z + -40.49961 \\ 0 &< 0.50007x^2 + 0.50004y^2 + 0.50003z^2 + 0.00009xy + 0.00002xz + 0.00004yz + 6.69291x + 10.62269y + 12.50413z + 106.97040 \end{aligned}$$

What is the volume of domain D ?



$$\iiint_D 1 dV$$

Calculus Problem 2

Let D be the intersection of 10 quadratics:

$$\begin{aligned} 0 &> 0.74742x^2 + 0.93022y^2 + 0.32256z^2 + 0.26590xy + -0.82750xz + 0.43517yz + 2.47974x + 26.97936y + 7.15111z + 171.27254 \\ 0 &> 0.00487x^2 + 0.00638y^2 + 0.00212z^2 + 0.00181xy + -0.00537xz + 0.00299yz + 0.51989x + -0.07938y + 0.87196z + 36.54138 \\ 0 &< -0.00469x^2 + 0.00617y^2 + -0.00134z^2 + 0.00116xy + 0.00609xz + 0.00326yz + 0.52845x + -0.08488y + 0.86497z + -11.92745 \\ 0 &> 0.00180x^2 + 0.00647y^2 + 0.00497z^2 + -0.00039xy + 0.00597xz + 0.00003yz + 0.59729x + -0.12904y + 0.98774z + 37.27755 \\ 0 &> 0.00173x^2 + 0.00681y^2 + 0.00479z^2 + -0.00022xy + 0.00574xz + 0.00034yz + -0.76442x + 0.12037y + 0.67647z + 27.71845 \\ 0 &> 0.00180x^2 + 0.00657y^2 + 0.00498z^2 + -0.00037xy + 0.00599xz + 0.00008yz + -0.76185x + 0.11119y + 0.68028z + 27.63880 \\ 0 &< -0.00156x^2 + 0.00591y^2 + -0.00403z^2 + 0.00324xy + -0.00503xz + 0.00601yz + -0.90629x + 0.19555y + 0.44420z + -24.48200 \\ 0 &> 0.00643x^2 + 0.00046y^2 + 0.00614z^2 + -0.00143xy + -0.00036xz + -0.00301yz + -0.04751x + -1.00153y + -0.12108z + 11.02481 \\ 0 &> 0.00323x^2 + -0.00046y^2 + -0.00276z^2 + 0.00209xy + -0.01145xz + 0.00273yz + -0.19156x + -0.92584y + -0.35667z + -40.49961 \\ 0 &< 0.50007x^2 + 0.50004y^2 + 0.50003z^2 + 0.00009xy + 0.00002xz + 0.00004yz + 6.69291x + 10.62269y + 12.50413z + 106.97040 \end{aligned}$$

What is the volume of domain D ?



$$\iiint_D 1 dV = \frac{4}{3} (10^2 - 5^2)^{\frac{3}{2}}$$

Calculus Problem 2

Let D be the intersection of 10 quadratics:

$$\begin{aligned} 0 &> 0.74742x^2 + 0.93022y^2 + 0.32256z^2 + 0.26590xy + -0.82750xz + 0.43517yz + 2.47974x + 26.97936y + 7.15111z + 171.27254 \\ 0 &> 0.00487x^2 + 0.00638y^2 + 0.00212z^2 + 0.00181xy + -0.00537xz + 0.00299yz + 0.51989x + -0.07938y + 0.87196z + 36.54138 \\ 0 &< -0.00469x^2 + 0.00617y^2 + -0.00134z^2 + 0.00116xy + 0.00609xz + 0.00326yz + 0.52845x + -0.08488y + 0.86497z + -11.92745 \\ 0 &> 0.00180x^2 + 0.00647y^2 + 0.00497z^2 + -0.00039xy + 0.00597xz + 0.00003yz + 0.59729x + -0.12904y + 0.98774z + 37.27755 \\ 0 &> 0.00173x^2 + 0.00681y^2 + 0.00479z^2 + -0.00022xy + 0.00574xz + 0.00034yz + -0.76442x + 0.12037y + 0.67647z + 27.71845 \\ 0 &> 0.00180x^2 + 0.00657y^2 + 0.00498z^2 + -0.00037xy + 0.00599xz + 0.00008yz + -0.76185x + 0.11119y + 0.68028z + 27.63880 \\ 0 &< -0.00156x^2 + 0.00591y^2 + -0.00403z^2 + 0.00324xy + -0.00503xz + 0.00601yz + -0.90629x + 0.19555y + 0.44420z + -24.48200 \\ 0 &> 0.00643x^2 + 0.00046y^2 + 0.00614z^2 + -0.00143xy + -0.00036xz + -0.00301yz + -0.04751x + -1.00153y + -0.12108z + 11.02481 \\ 0 &> 0.00323x^2 + -0.00046y^2 + -0.00276z^2 + 0.00209xy + -0.01145xz + 0.00273yz + -0.19156x + -0.92584y + -0.35667z + -40.49961 \\ 0 &< 0.50007x^2 + 0.50004y^2 + 0.50003z^2 + 0.00009xy + 0.00002xz + 0.00004yz + 6.69291x + 10.62269y + 12.50413z + 106.97040 \end{aligned}$$

What is the volume of domain D ?



$$\iiint_D 1 dV = \frac{4}{3} (10^2 - 5^2)^{\frac{3}{2}}$$

Calculus Problem 2

Let D

$0 > 0.74747$
 $0 > 0.00487$
 $0 < -0.00469$
 $0 > 0.00180$
 $0 > 0.00173$
 $0 > 0.00180$
 $0 < -0.00156$
 $0 > 0.00643$
 $0 > 0.00323$
 $0 < 0.50007$

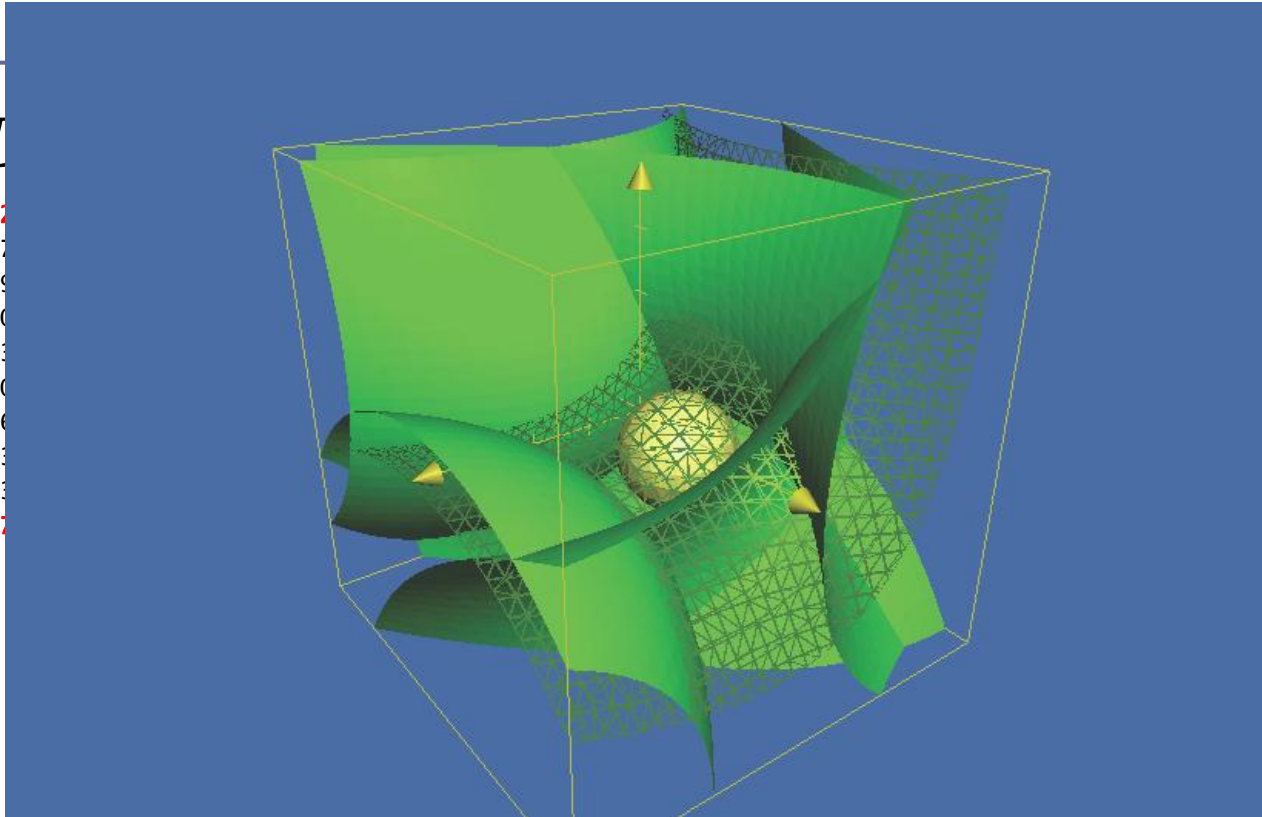

$+ 7.15111z + 171.27254$
 $+ 0.87196z + 36.54138$
 $+ 0.86497z + -11.92745$
 $+ 0.98774z + 37.27755$
 $+ 0.67647z + 27.71845$
 $+ 0.68028z + 27.63880$
 $+ 0.44420z + -24.48200$
 $+ -0.12108z + 11.02481$
 $+ -0.35667z + -40.49961$
 $+ 12.50413z + 106.97040$

What is the volume of domain D ?



$$\iiint_D 1 dV = \frac{4}{3} (10^2 - 5^2)^{\frac{3}{2}}$$

Difficulty: Finding the domain.

Basic idea: *Divide-and-conquer*.

Recursively decompose space into boxes, determining the surfaces affecting each box, stopping when the box is small enough or surfaces are simple enough that we can approximate volume accurately.

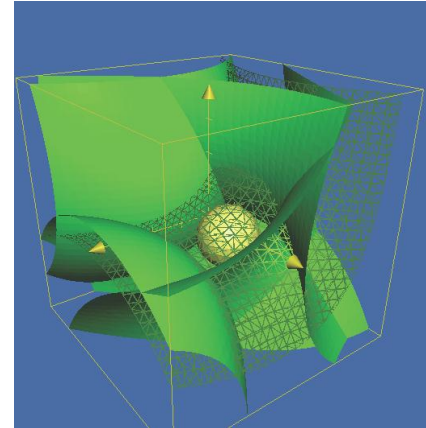

Our contribution: Framework that computes each component's volume in multi-comp. CSG models. Based on a minimal, extensible set of predicates that handles any model & is very efficient on common cases.

Overview

The framework uses analytic, stochastic and numerical integration, as appropriate.

Basic steps:

- Subdivide the model into boxes
- Identify boxes that are “easy” to integrate
 - difficult boxes are further subdivided
- Apply “best” integrator for each box.

Model Name	Alg	Time (sec)
cPiped100	Old	790.28
tol: $\pm 1.1e-04$	New	1.41

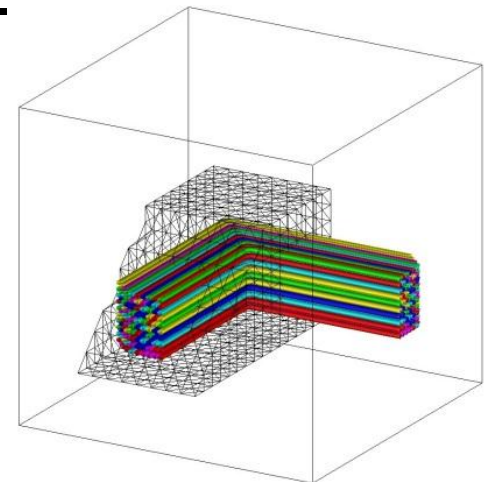

Primitives: Signed Quadratic Surfaces

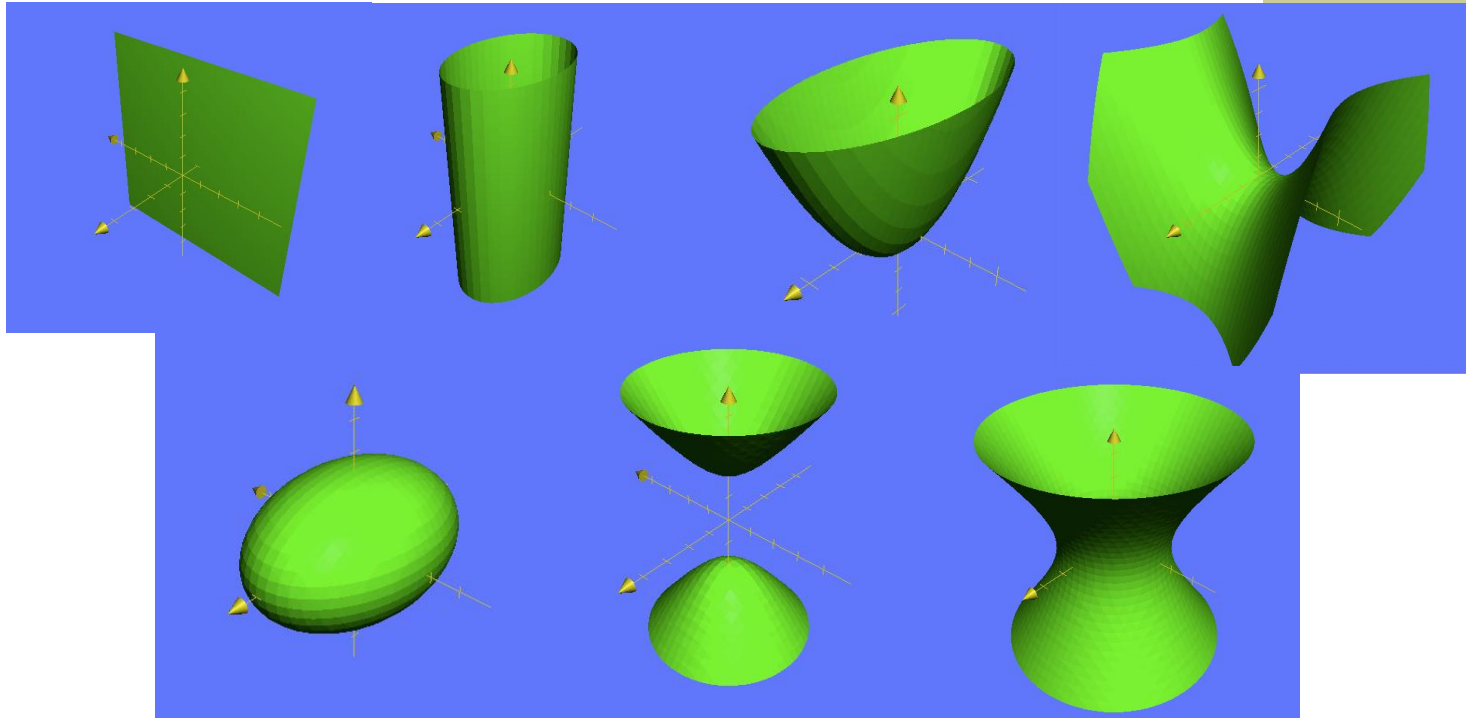

$$f(x, y, z) = Ax^2 + By^2 + Cz^2 \\ + Dxy + Exz + Fyz \\ + Gx + Hy + Iz + J$$

Primitives: Signed Quadratic Surfaces

Visual Notation

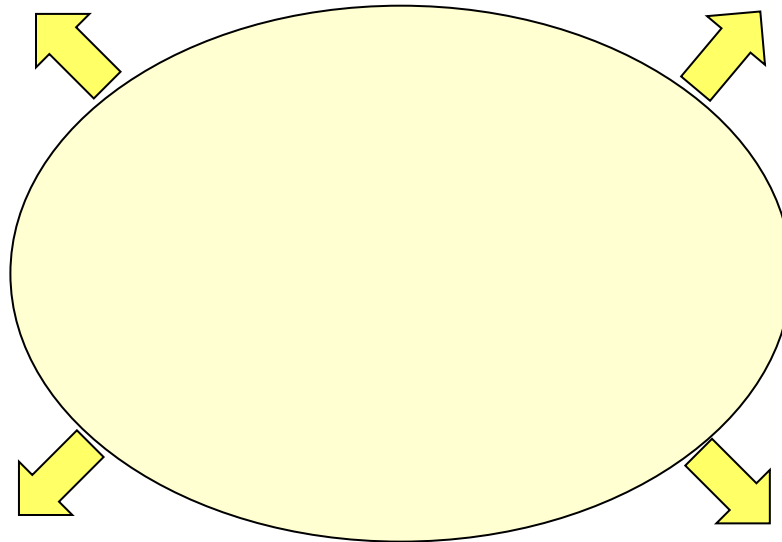

$$f(x, y, z) = Ax^2 + By^2 + Cz^2 \\ + Dxy + Exz + Fyz \\ + Gx + Hy + Iz + J$$

Operation on Primitives

Operations on signed surface S with point or box:

Required:

- *Point inside* – return if query point is inside S .
- *Box classification* – return if the points of an axis-aligned box are inside, outside or both with respect to S .
- *Integrator* – return the intersection volume of the interior of S with an axis-aligned box.

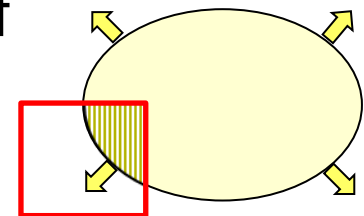
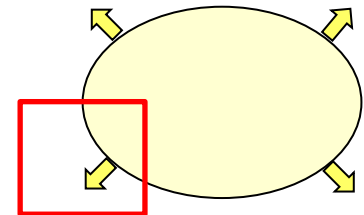
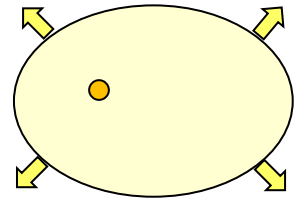

Primitive Operations: Common Cases

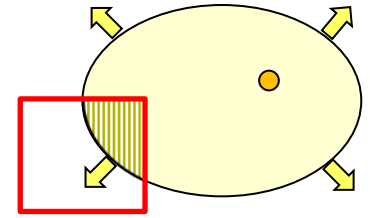

- Planes

Point inside: $\text{sign}(Ax + By + Cz + D)$

Box classification: simply test box vertices

- Extruded conics

Point inside: $\text{sign}(Ax^2 + By^2 + Cxy + Dx + Ey + F)$

Box classification: test 2d-box vertices and edges.

- Right circular cylinder (extends extruded conic)

Point inside: squared distance comparison

Box classification: from Extruded conic

Model Representation

Basic Component: Boolean Formula

A *basic component* defined by intersections and unions of signed surfaces

$$\left(-S_{blue} \cap S_{grey} \cap S_{green} \cap -S_{orange}\right) \cup -S_{yellow}$$

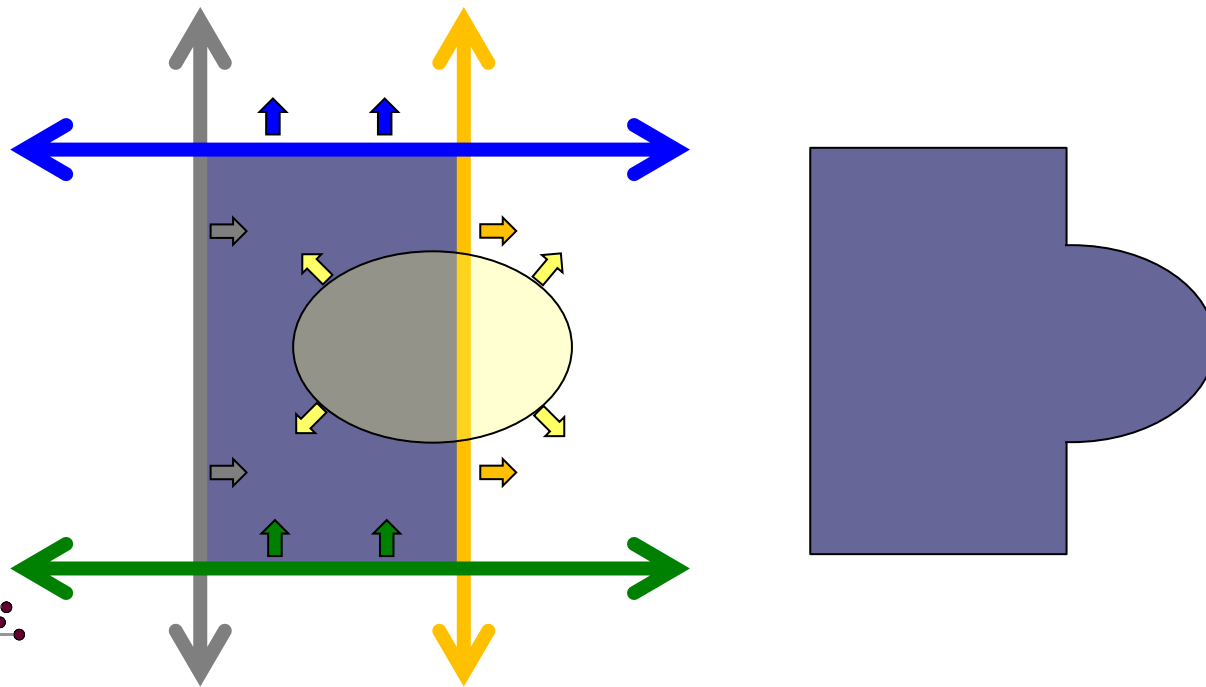

Model Representation

Component Hierarchy: Boolean Formulae

Basic comp: $B(N)$, \cup and \cap of signed surfs.

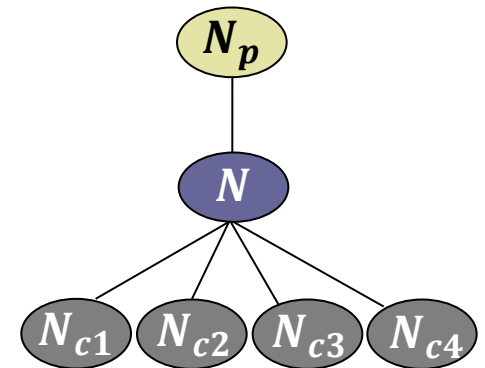
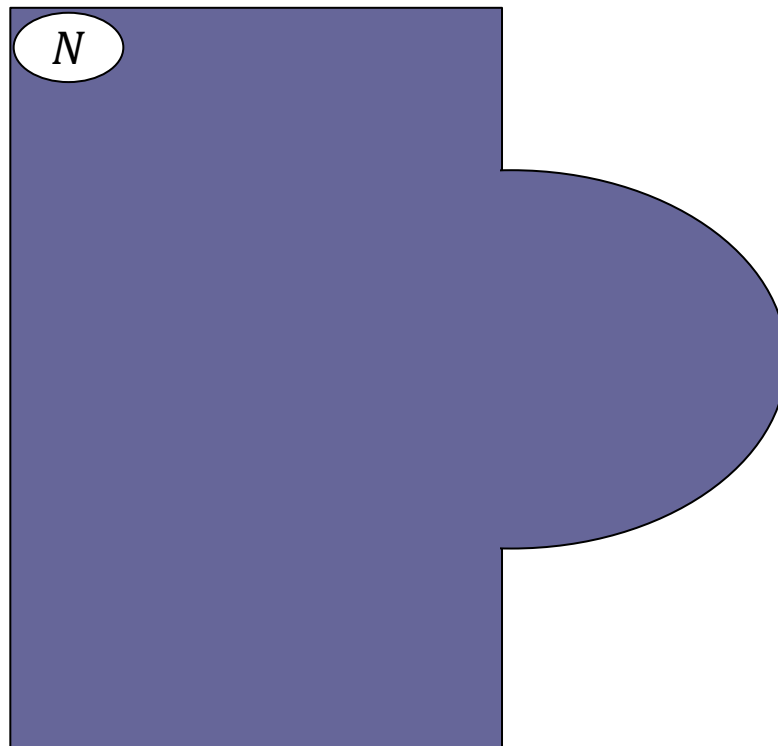

Model Representation

Component Hierarchy: Boolean Formulae

Basic comp: $B(N)$, \cup and \cap of signed surfs.

Restricted comp: $R(N) = B(N) \cap R(N_p)$

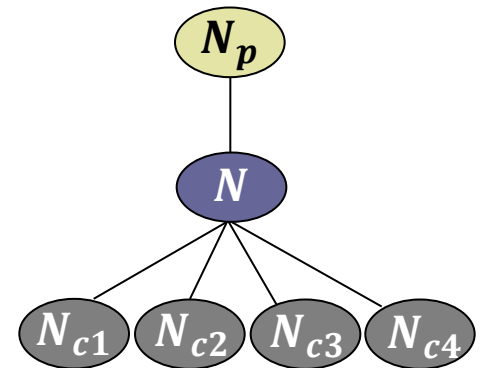
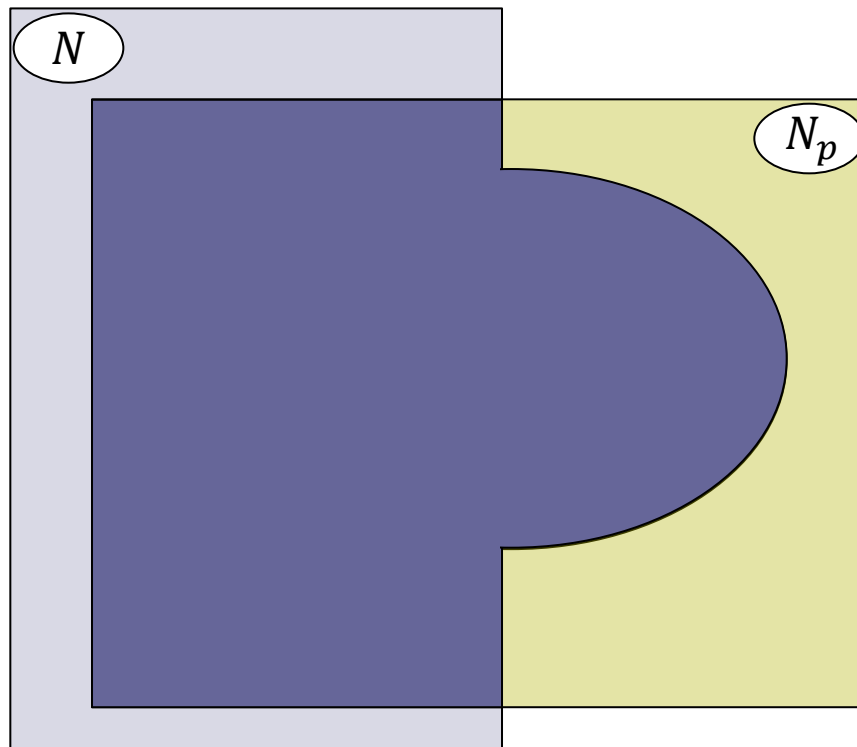

Model Representation

Component Hierarchy: Boolean Formulae

Basic comp: $B(N)$, \cup and \cap of signed surfs.

Restricted comp: $R(N) = B(N) \cap R(N_p)$

Hierarchical comp: $H(N) = R(N) \setminus \sum_i R(N_{ci})$

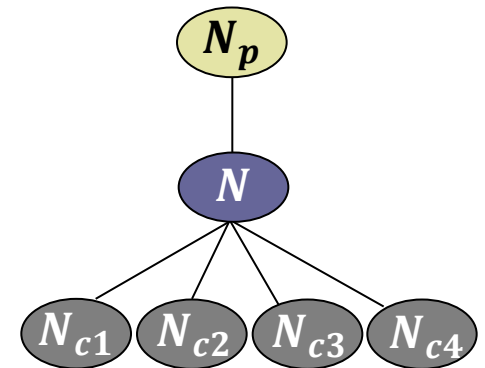
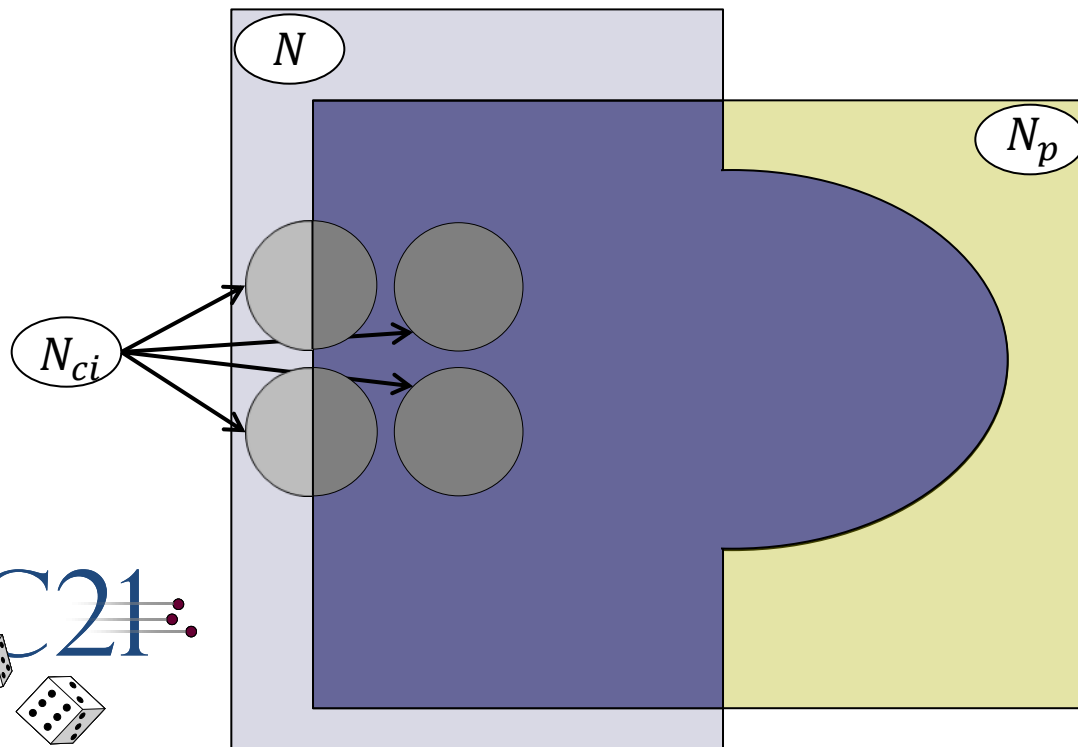

Model Operations

Component Hierarchy: Boolean Formulae

Operations for a comp. hierarchy:

Required:

- *Point location* – return the hierarchical comp. containing a point.
- *Formula restricted to a box* – given an axis aligned box b , a Boolean formula F and the classification for all surfs of F for b , replace all surfs of F in which b is completely inside or outside with True or False respectively.

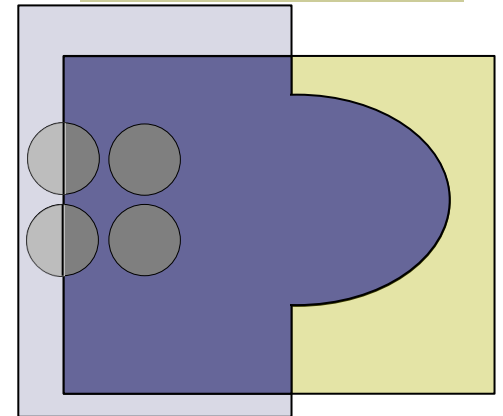

Model Operations

Component Hierarchy: Boolean Formulae

- *Formula restricted to a box* – given an axis aligned box b , a Boolean formula F and the classification for all surfs of F for b , replace all surfs of F in which b is completely inside or outside with True or False respectively.

$$(-S_{blue} \cap S_{grey} \cap S_{green} \cap -S_{orange}) \cup -S_{yellow}$$

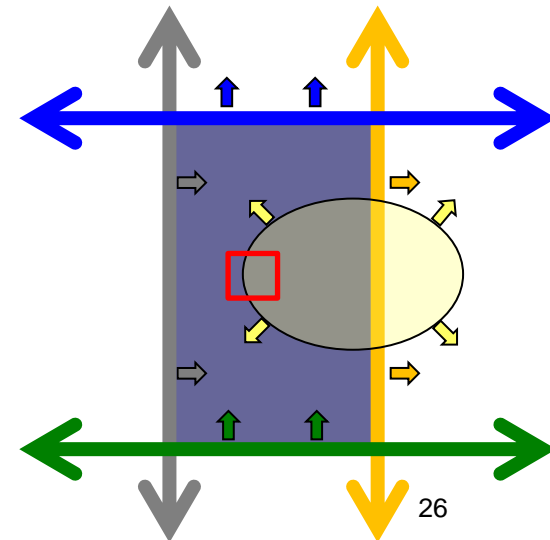

Model Operations

Component Hierarchy: Boolean Formulae

- *Formula restricted to a box* – given an axis aligned box b , a Boolean formula F and the classification for all surfs of F for b , replace all surfs of F in which b is completely inside or outside with True or False respectively.

$$(-S_{blue} \cap S_{grey} \cap S_{green} \cap -S_{orange}) \cup -S_{yellow}$$

$$(T \cap T \cap T \cap T) \cup -S_{yellow}$$

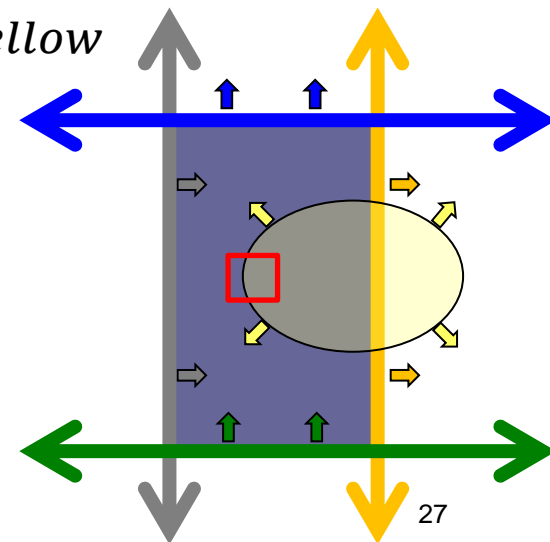

Model Operations

Component Hierarchy: Boolean Formulae

- *Formula restricted to a box* – given an axis aligned box b , a Boolean formula F and the classification for all surfs of F for b , replace all surfs of F in which b is completely inside or outside with True or False respectively.

$$(-S_{blue} \cap S_{grey} \cap S_{green} \cap -S_{orange}) \cup -S_{yellow}$$

$$(T \cap T \cap T \cap T) \cup -S_{yellow}$$

$$(T) \cup -S_{yellow}$$

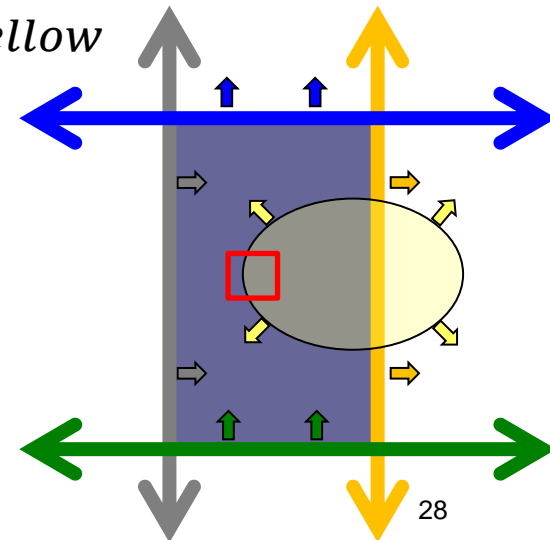

Model Operations

Component Hierarchy: Boolean Formulae

- *Formula restricted to a box* – given an axis aligned box b , a Boolean formula F and the classification for all surfs of F for b , replace all surfs of F in which b is completely inside or outside with True or False respectively.

$$(-S_{blue} \cap S_{grey} \cap S_{green} \cap -S_{orange}) \cup -S_{yellow}$$

$$(T \cap T \cap T \cap T) \cup -S_{yellow}$$

$$(T) \cup -S_{yellow}$$

$$T$$

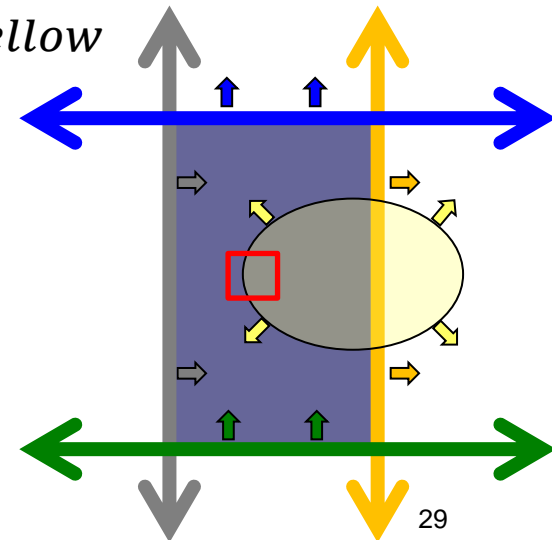

Model Operations

Component Hierarchy: Boolean Formulae

- *Formula restricted to a box* – given an axis aligned box b , a Boolean formula F and the classification for all surfs of F for b , replace all surfs of F in which b is completely inside or outside with True or False respectively.

$$(-S_{blue} \cap S_{grey} \cap S_{green} \cap -S_{orange}) \cup -S_{yellow}$$

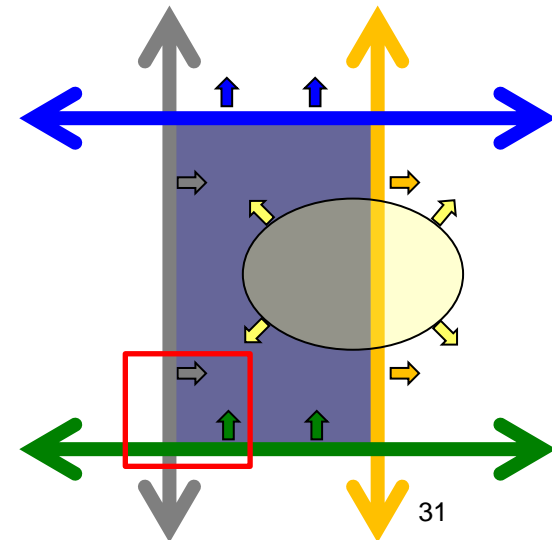

Model Operations

Component Hierarchy: Boolean Formulae

- *Formula restricted to a box* – given an axis aligned box b , a Boolean formula F and the classification for all surfs of F for b , replace all surfs of F in which b is completely inside or outside with True or False respectively.

$$(-S_{blue} \cap S_{grey} \cap S_{green} \cap -S_{orange}) \cup -S_{yellow}$$

$$(T \cap S_{grey} \cap S_{green} \cap T) \cup F$$

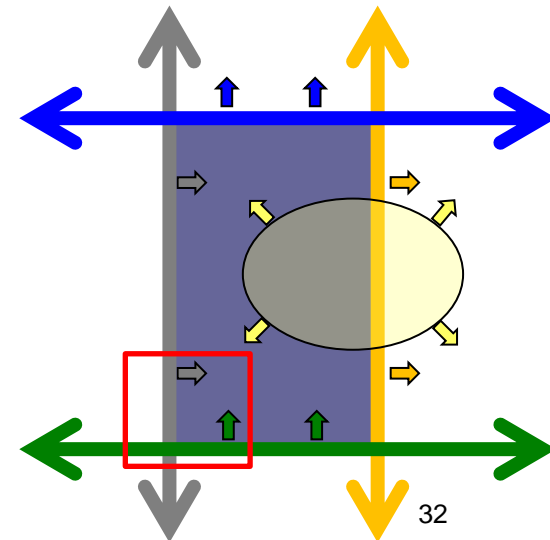

Model Operations

Component Hierarchy: Boolean Formulae

- *Formula restricted to a box* – given an axis aligned box b , a Boolean formula F and the classification for all surfs of F for b , replace all surfs of F in which b is completely inside or outside with True or False respectively.

$$(-S_{blue} \cap S_{grey} \cap S_{green} \cap -S_{orange}) \cup -S_{yellow}$$

$$\left(T \cap S_{grey} \cap S_{green} \cap T \right) \cup F$$
$$(S_{grey} \cap S_{green})$$

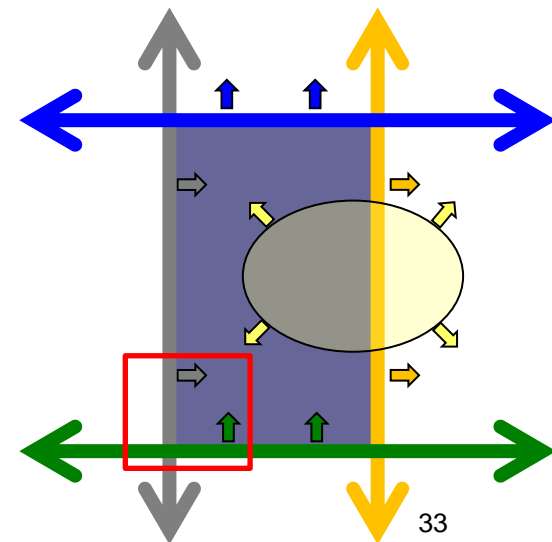

Surface-in-Box Integrators

Given a component hierarchy, axis-aligned box b , and target error ε and confidence δ , an *integrator* either computes volumes of each hierarchical comp's intersection with b to within ε and δ , or flags b as “needs subdivision.”

Basic integrators:

- *Monte Carlo Integrator (MC)*
- *Box Integrator (Box)*

Advanced integrators:

- *Pair of Planes Integrator (2Plane)*
- *Bundle of Cylinders Integrator (BunCyl)*

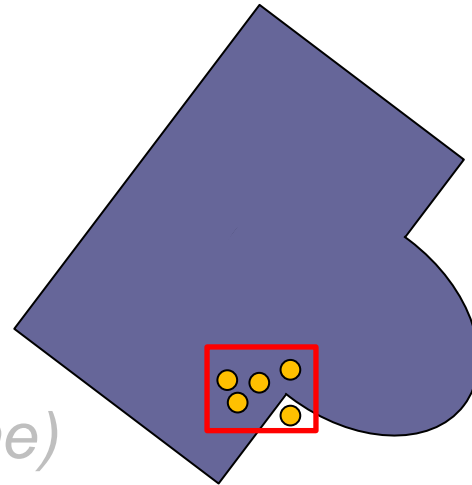

Surface-in-Box Integrators

Given a component hierarchy, axis-aligned box b , and target error ε and confidence δ , an *integrator* either computes volumes of each hierarchical comp's intersection with b to within ε and δ , or flags b as “needs subdivision.”

Basic integrators:

- *Monte Carlo Integrator (MC)*
- *Box Integrator (Box)*

Advanced integrators:

- *Pair of Planes Integrator (2Plane)*
- *Bundle of Cylinders Integrator (BunCyl)*

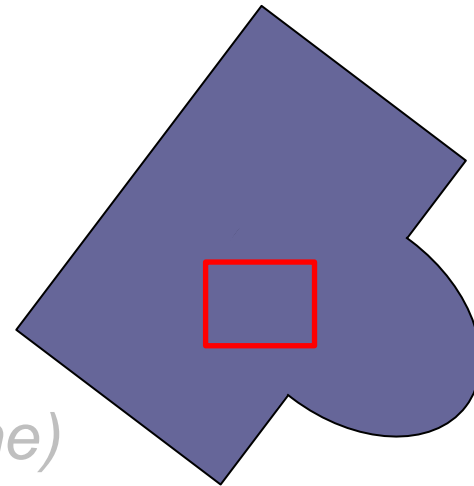

Surface-in-Box Integrators

Given a component hierarchy, axis-aligned box b , and target error ε and confidence δ , an *integrator* either computes volumes of each hierarchical comp's intersection with b to within ε and δ , or flags b as “needs subdivision.”

Basic integrators:

- *Monte Carlo Integrator (MC)*
- *Box Integrator (Box)*

Advanced integrators:

- *Pair of Planes Integrator (2Plane)*
- *Bundle of Cylinders Integrator (BunCyl)*

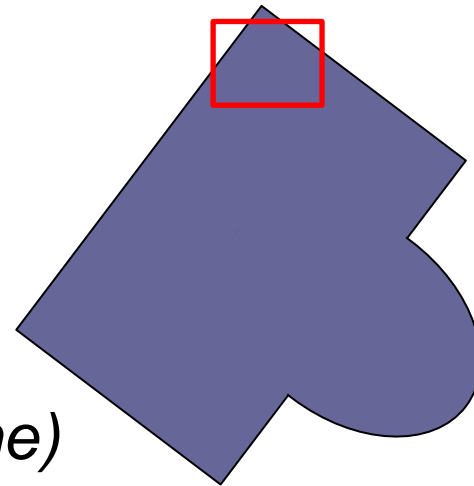

Surface-in-Box Integrators

Given a component hierarchy, axis-aligned box b , and target error ε and confidence δ , an *integrator* either computes volumes of each hierarchical comp's intersection with b to within ε and δ , or flags b as “needs subdivision.”

Basic integrators:

- *Monte Carlo Integrator (MC)*
- *Box Integrator (Box)*

Advanced integrators:

- *Pair of Planes Integrator (2Plane)*
- *Bundle of Cylinders Integrator (BunCyl)*

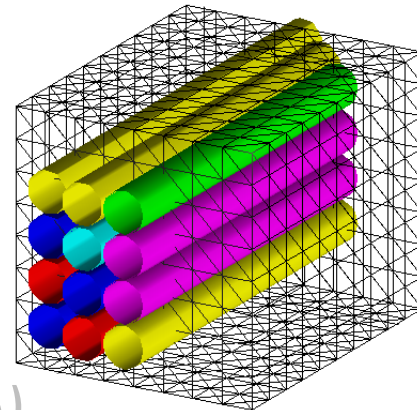

Algorithm Animation

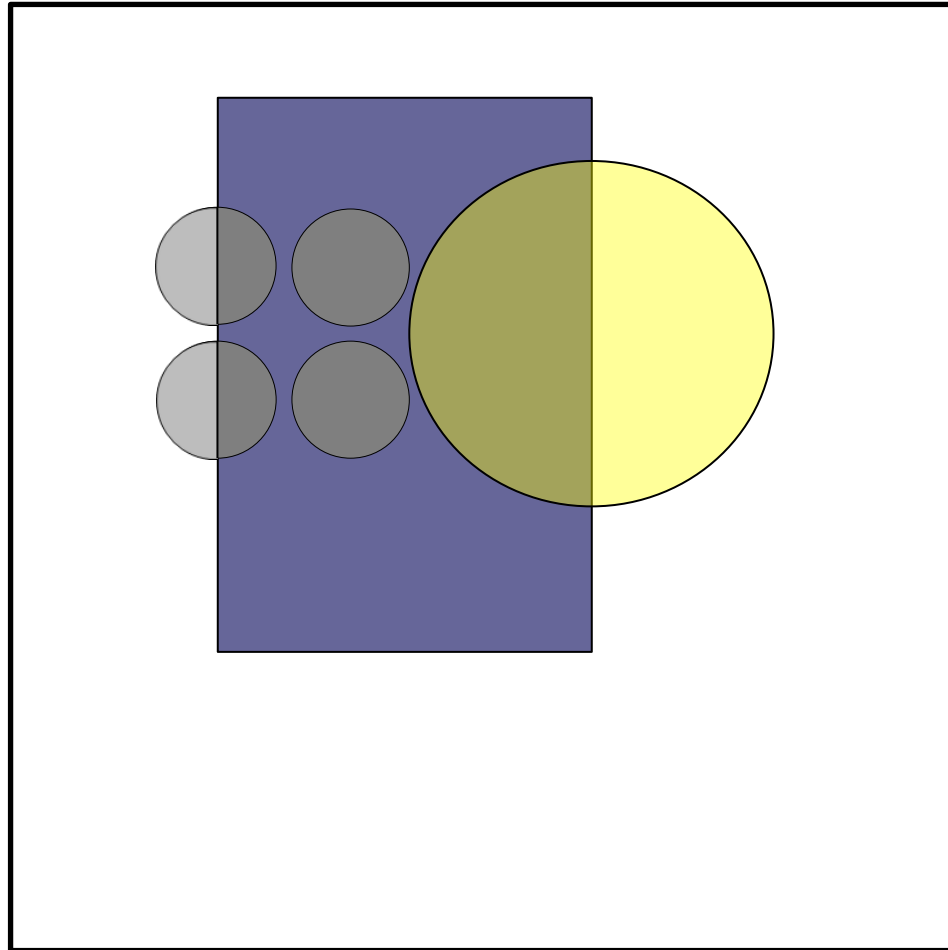

Algorithm Animation

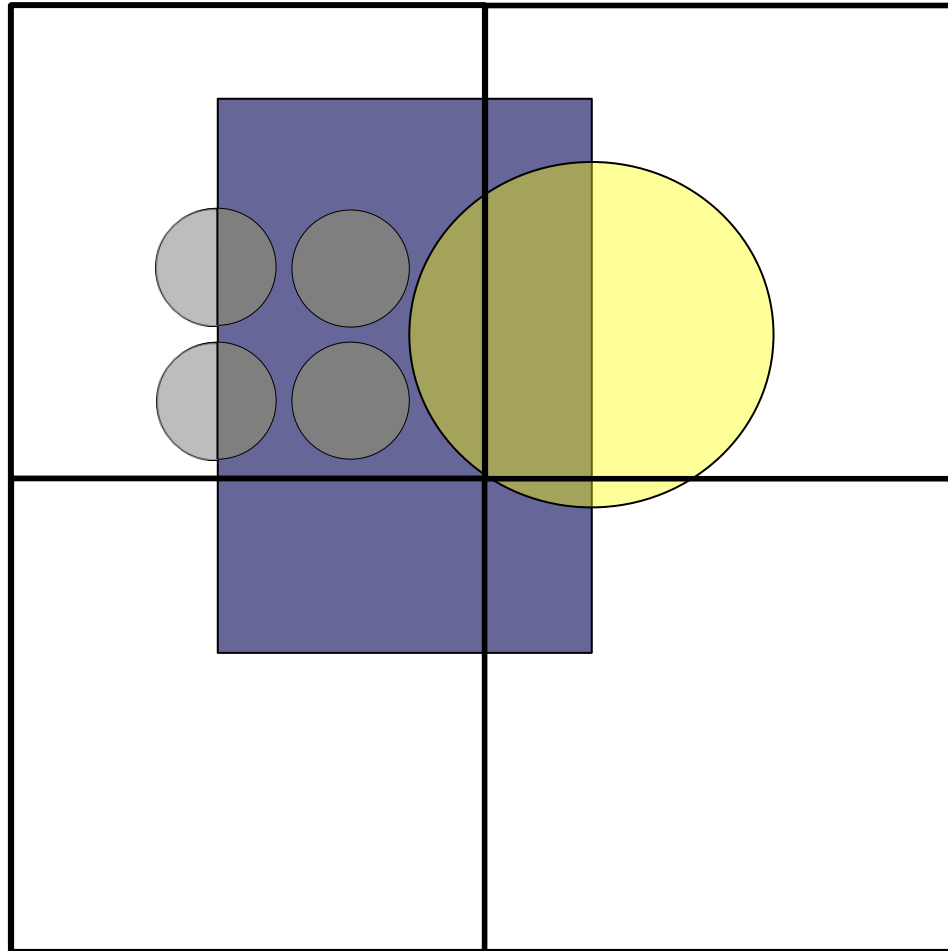

Algorithm Animation

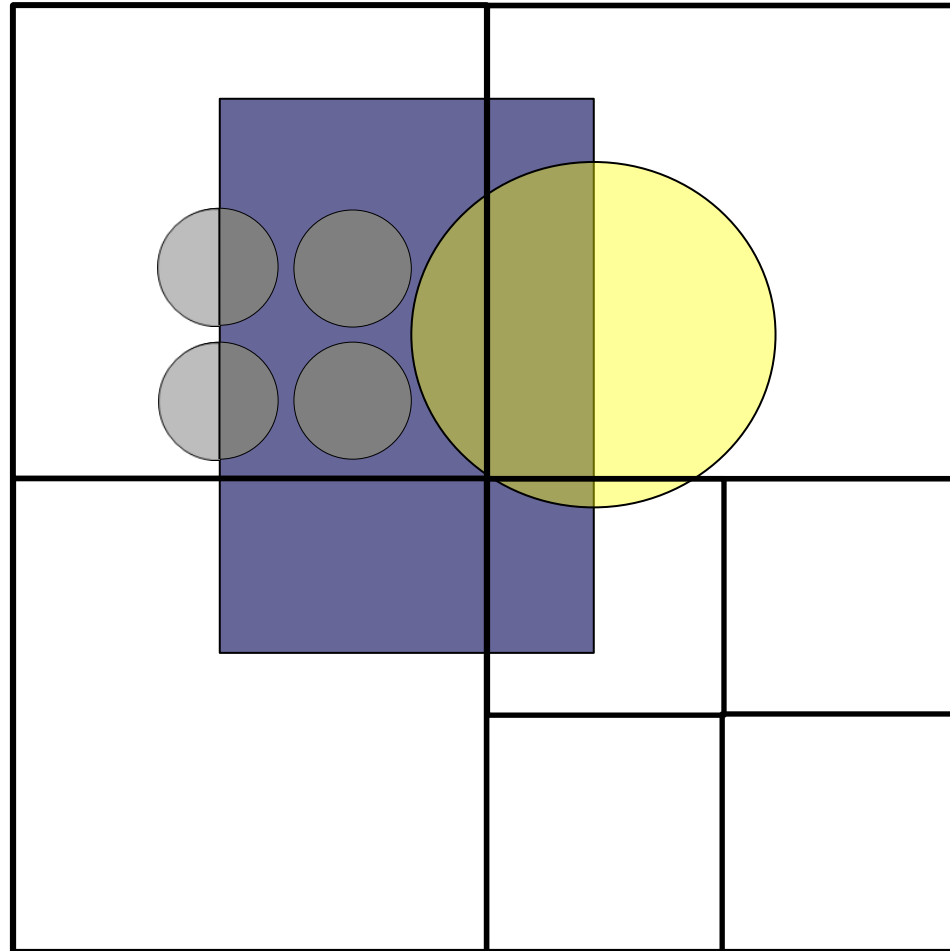

Algorithm Animation

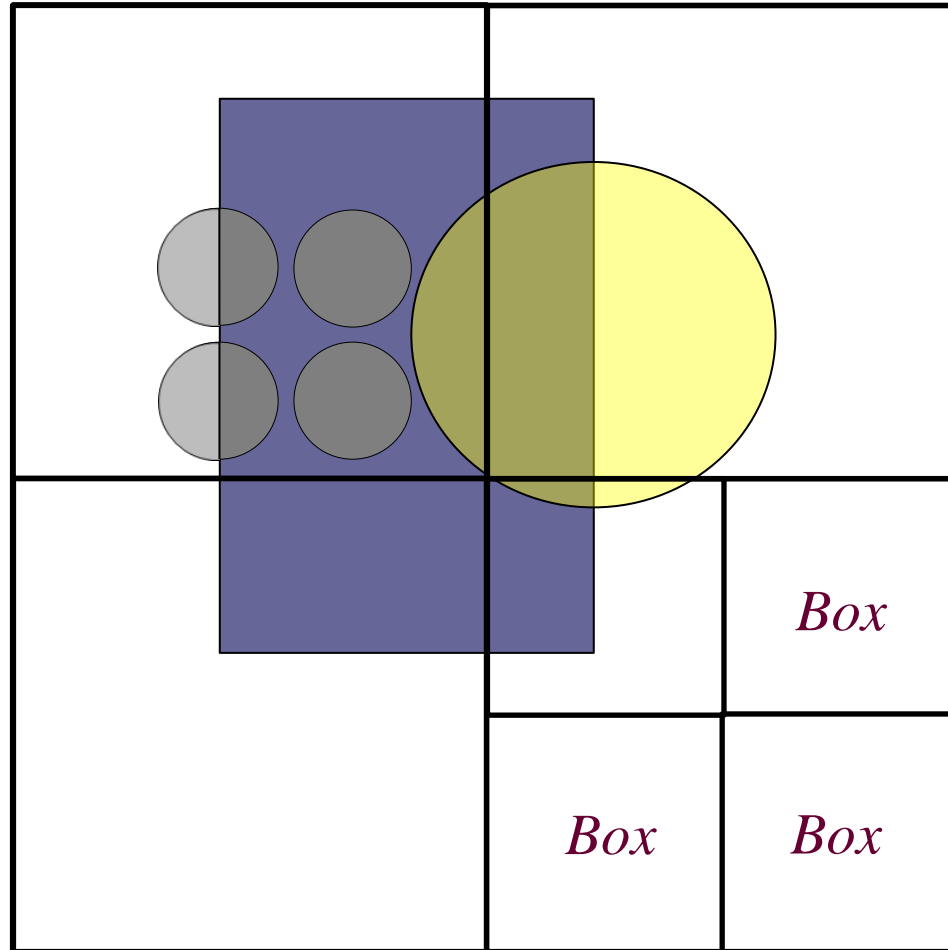

Algorithm Animation

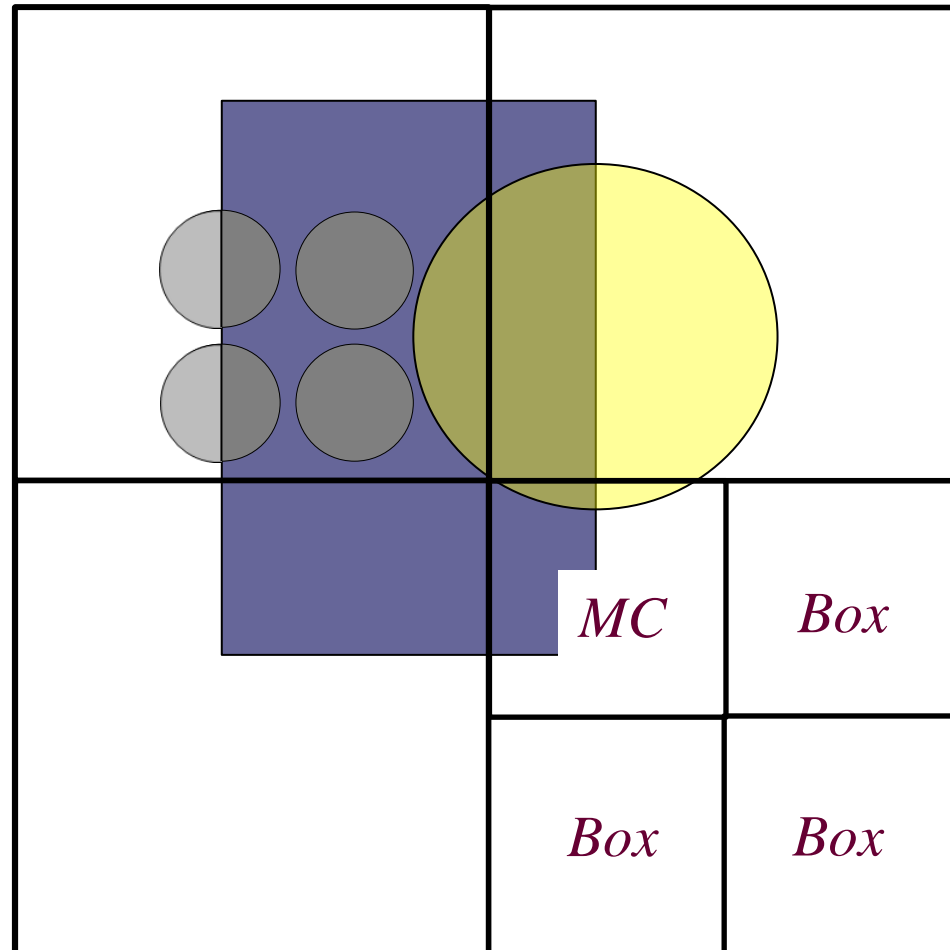

Algorithm Animation

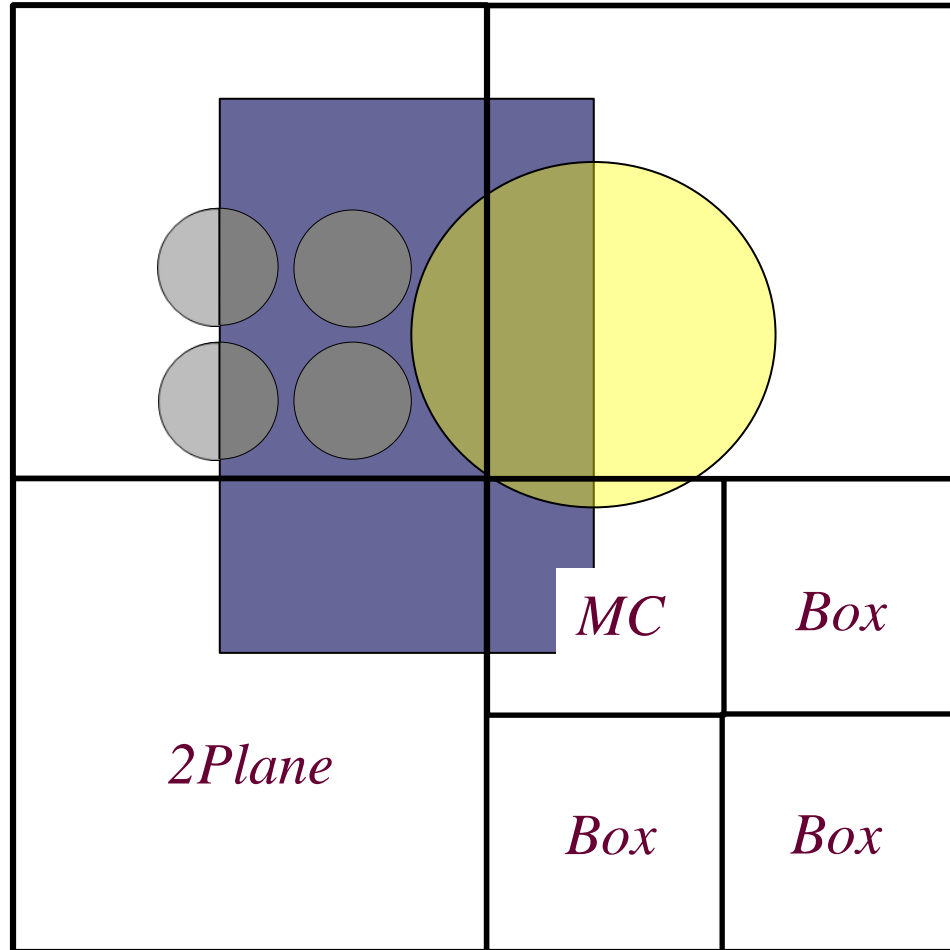

Algorithm Animation

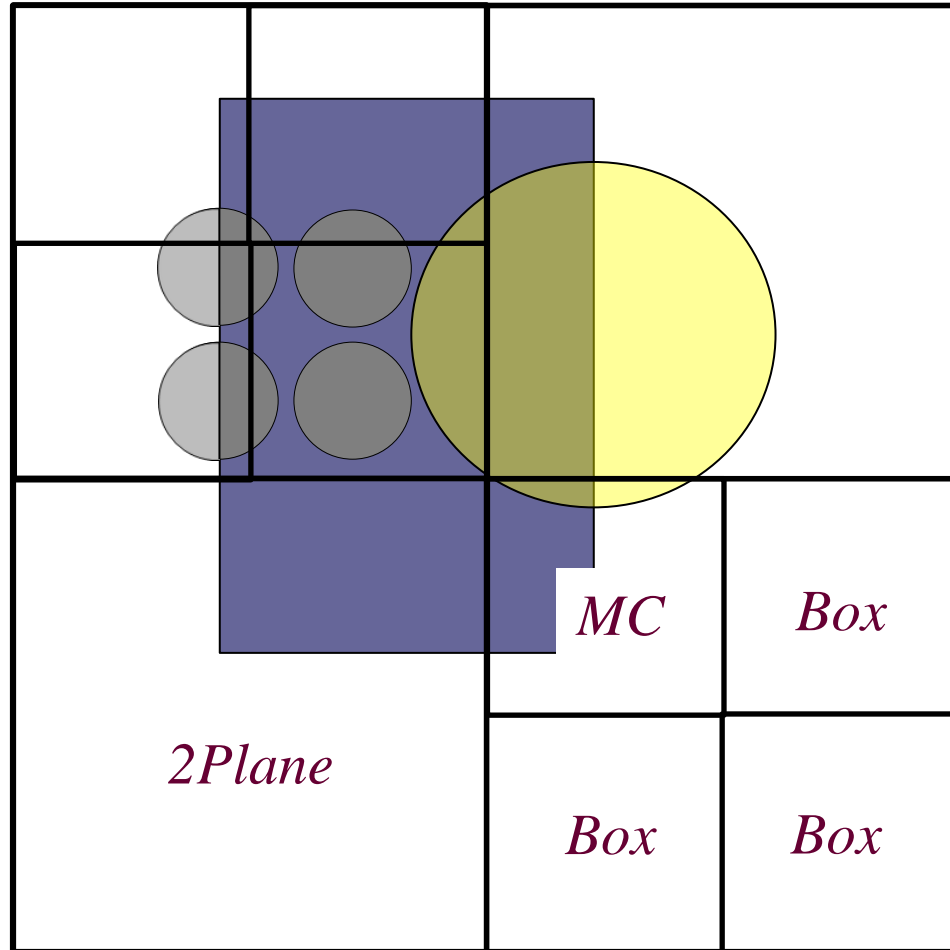

Algorithm Animation

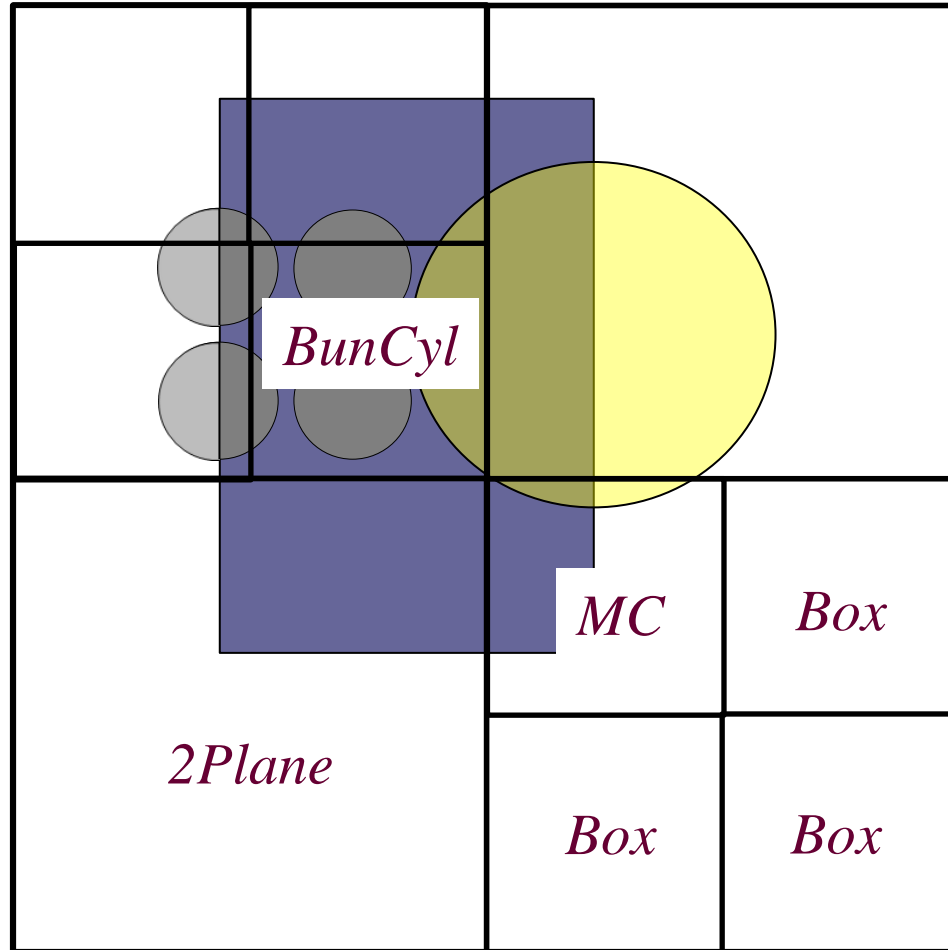

Algorithm Animation

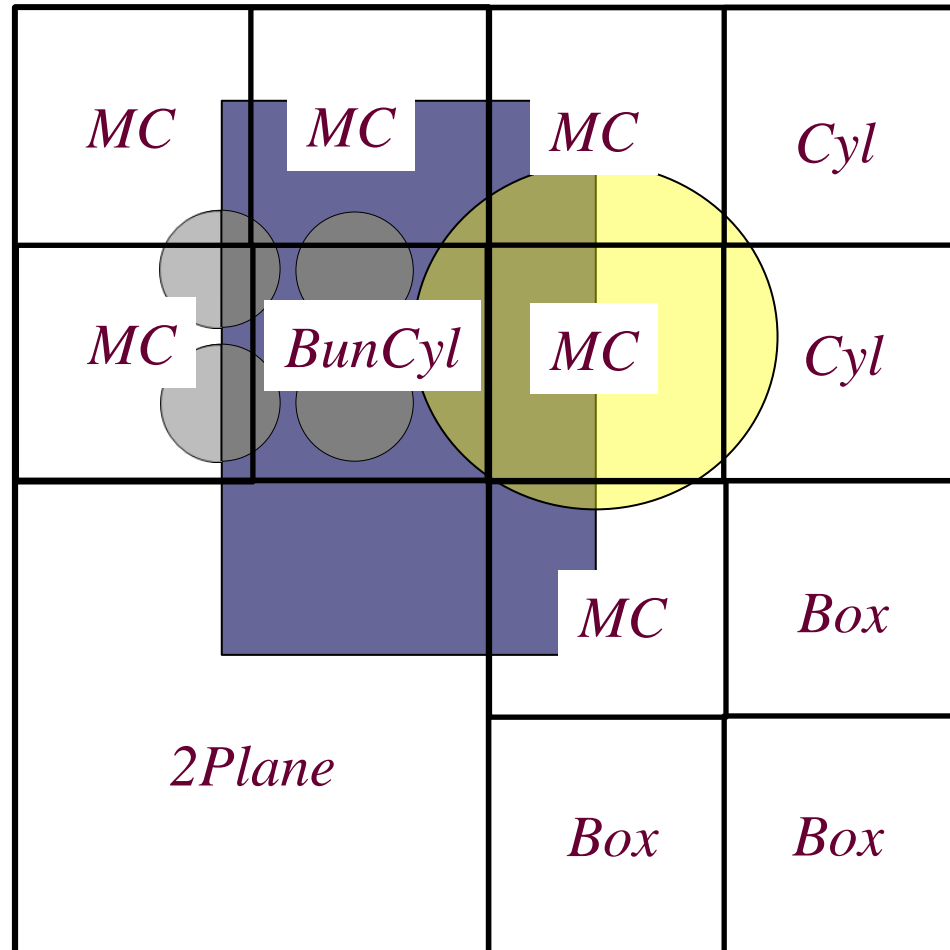

Experiment: Models

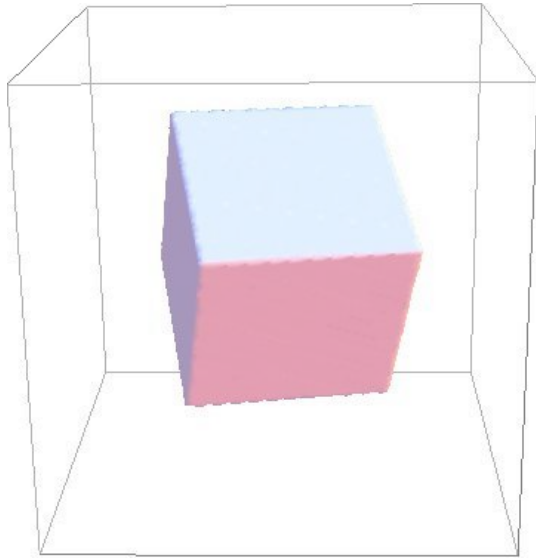

Cube

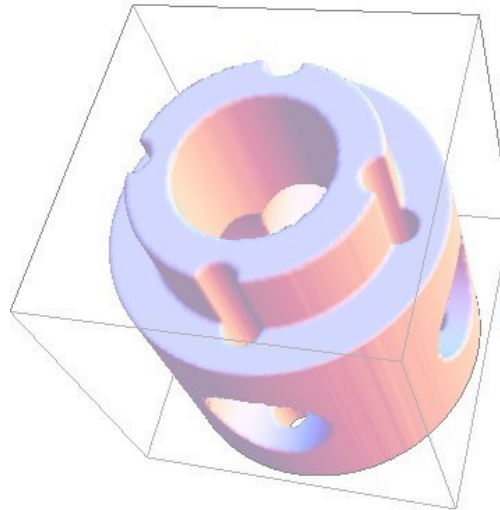

DrillCyl

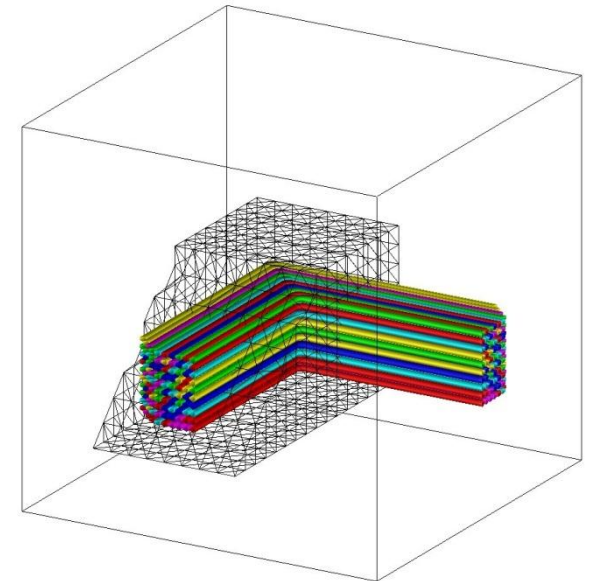

cPiped12,
cPiped100, and
cPiped10000

Experiment: Accuracy and Time

Model Name	Alg	Total Volume	Time (sec)
cPiped100 tol: $\pm 1.1e-04$	Analytic	0.0731 920	-

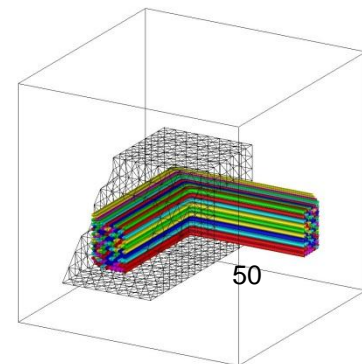

Experiment: Accuracy and Time

Model Name	Alg	Total Volume	Time (sec)
cPiped100 tol: $\pm 1.1e-04$	Analytic Monte Carlo (MC)	0.0731 920 0.0731 951	-

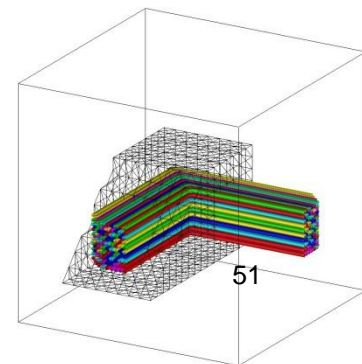

Experiment: Accuracy and Time

Model Name	Alg	Total Volume	Time (sec)
cPiped100 tol: $\pm 1.1e-04$	Analytic	0.0731920	-
	Monte Carlo (MC)	0.0731951	-
	+Subdivision & Box (Sdiv&Box)	0.0731921	-

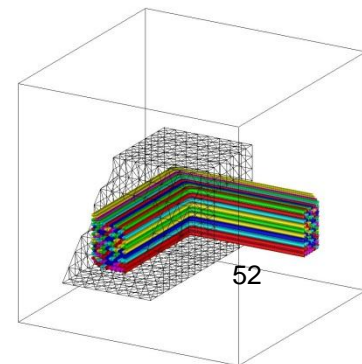

Experiment: Accuracy and Time

Model Name	Alg	Total Volume	Time (sec)
cPiped100 tol: $\pm 1.1e-04$	Analytic	0.0731920	-
	Monte Carlo (MC)	0.0731951	
	+Subdivision & Box (Sdiv&Box)	0.0731921	
	+Pair of Planes (2 Plane)	0.0731919	
	+Bundle of Cylinders (BunCyl)	0.0731919	

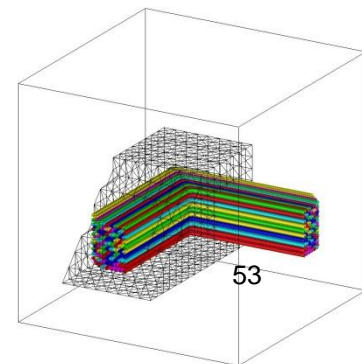

Experiment: Accuracy and Time

Model Name	Alg	Total Volume	Time (sec)
cPiped100 tol: $\pm 1.1e-04$	Analytic	0.0731920	-
	MC	0.0731951	
	+Sdiv&Box	0.0731921	
	+2Plane	0.0731919	
	+BunCyl	0.0731919	

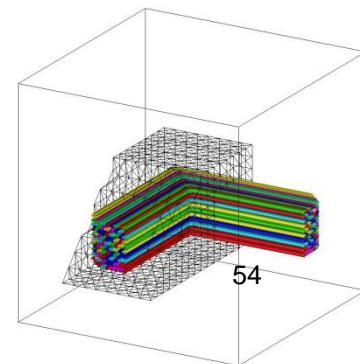

Experiment: Accuracy and Time

Model Name	Alg	Total Volume	Time (sec)
cPiped100 tol: $\pm 1.1e-04$	Analytic	0.0731920	-
	MC	0.0731951	790.28
	+Sdiv&Box	0.0731921	63.96
	+2Plane	0.0731919	51.32
	+BunCyl	0.0731919	1.41

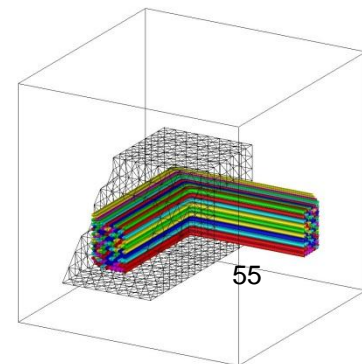

Experiment: Accuracy and Time

Model Name	Alg	Total Volume	Time (sec)
cPiped100 tol: $\pm 1.1e-04$	Analytic	0.0731920	-
	MC	0.0731951	790.28
	+Sdiv&Box	0.0731921	63.96
	+2Plane	0.0731919	51.32
	+BunCyl	0.0731919	1.41

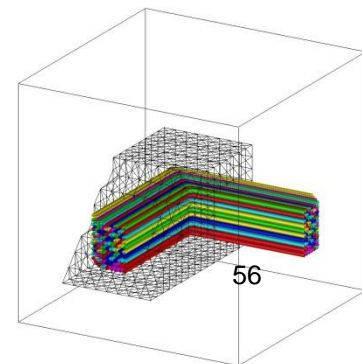

Experiment: # Boxes Impact Time

Model Name	Alg	Total Boxes	Integrators (% of total boxes)				Time (sec)
			MC	Box	2Plane	BunCyl	
cPiped100 tol: $\pm 1.1e-04$ vol: 0.0731920	MC	1	100.0	-	-	-	790.28

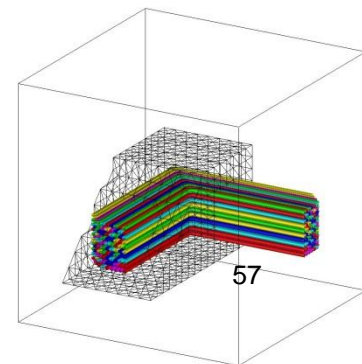

Experiment: # Boxes Impact Time

Model Name	Alg	Total Boxes	Integrators (% of total boxes)				Time (sec)
			MC	Box	2Plane	BunCyl	
cPiped100 tol: $\pm 1.1e-04$ vol: 0.0731920	MC	1	100.0	-	-	-	790.28
	+Sdiv&Box	62,392,744	45.2	54.8	-	-	63.96

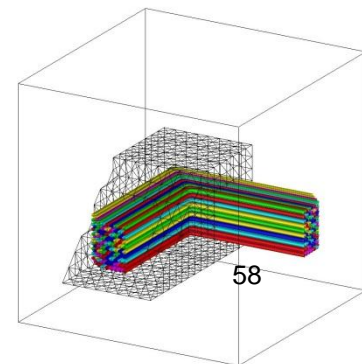

Experiment: # Boxes Impact Time

Model Name	Alg	Total Boxes	Integrators (% of total boxes)				Time (sec)
			MC	Box	2Plane	BunCyl	
cPiped100	MC	1	100.0	-	-	-	790.28
tol: $\pm 1.1e-04$	+Sdiv&Box	62,392,744	45.2	54.8	-	-	63.96
vol: 0.0731920	+2 Plane	48,958,575	45.6	54.2	<0.1	-	51.32
	+BunCyl	482,756	16.8	49.6	11.8	3.3	1.41

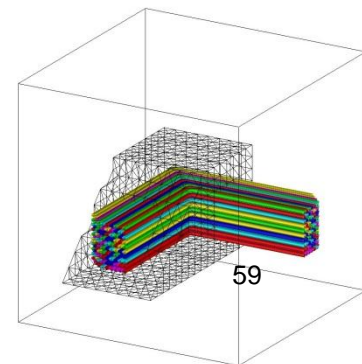

Experiment: # Boxes Impact Time

Model Name	Alg	Total Boxes	Integrators (% of total boxes)				Time (sec)
			MC	Box	2Plane	BunCyl	
cPiped100 tol: $\pm 1.1e-04$ vol: 0.0731920	MC	1	100.0	-	-	-	790.28
	+Sdiv&Box	62,392,744	45.2	54.8	-	-	63.96
	+2 Plane	48,958,575	45.6	54.2	<0.1	-	51.32
	+BunCyl	482,756	16.8	49.6	11.8	3.3	1.41

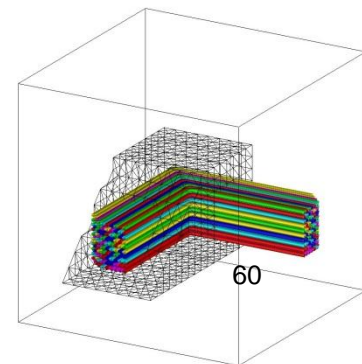

Experiment: Integrators Impact Time

Model Name	Alg	Total Boxes	Integrators (% of total boxes)				Time (sec)
			MC	Box	2Plane	BunCyl	
cPiped100	MC	1	100.0	-	-	-	790.28
tol: $\pm 1.1e-04$	+Sdiv&Box	62,392,744	45.2	54.8	-	-	63.96
vol: 0.0731920	+2 Plane	48,958,575	45.6	54.2	<0.1	-	51.32
	+BunCyl	482,756	16.8	49.6	11.8	3.3	1.41

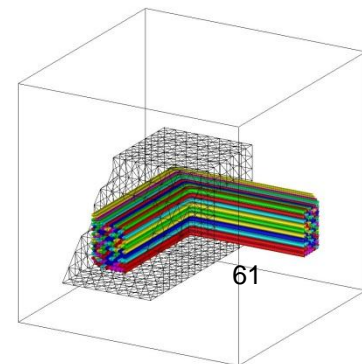

Experiment: Integrators Impact Time

Model Name	Alg	Total Boxes	Integrators (% of total boxes)				Time (sec)
			MC	Box	2Plane	BunCyl	
cPiped100	MC	1	100.0	-	-	-	790.28
tol: $\pm 1.1e-04$	+Sdiv&Box	62,392,744	45.2	54.8	-	-	63.96
vol: 0.0731920	+2 Plane	48,958,575	45.6	54.2	<0.1	-	51.32
	+BunCyl	482,756	16.8	49.6	11.8	3.3	1.41

Model Name	Alg	Integrators (% of total vol)				Total Samples	Time (sec)
		MC	Box	2Plane	BunCyl		
cPiped100	MC	100.0	-	-	-	1,410,065,909	790.28
tol: $\pm 1.1e-04$	+Sdiv&Box	0.3	99.7	-	-	56,352,288	63.96
vol: 0.0731920	+2 Plane	0.3	75.3	24.4	-	44,694,892	51.32
	+BunCyl	<0.1	70.5	24.3	5.0	162,002	1.41

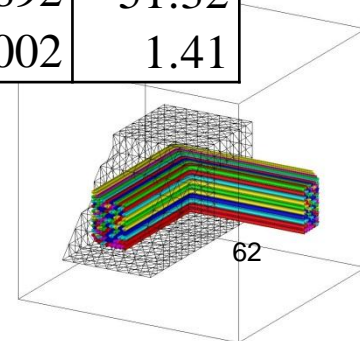

Experiment: Integrators Impact Time

Model Name	Alg	Total Boxes	Integrators (% of total boxes)				Time (sec)
			MC	Box	2Plane	BunCyl	
cPiped100	MC	1	100.0	-	-	-	790.28
tol: $\pm 1.1e-04$	+Sdiv&Box	62,392,744	45.2	54.8	-	-	63.96
vol: 0.0731920	+2 Plane	48,958,575	45.6	54.2	<0.1	-	51.32
	+BunCyl	482,756	16.8	49.6	11.8	3.3	1.41

Model Name	Alg	Integrators (% of total vol)				Total Samples	Time (sec)
		MC	Box	2Plane	BunCyl		
cPiped100	MC	100.0	-	-	-	1,410,065,909	790.28
tol: $\pm 1.1e-04$	+Sdiv&Box	0.3	99.7	-	-	56,352,288	63.96
vol: 0.0731920	+2 Plane	0.3	75.3	24.4	-	44,694,892	51.32
	+BunCyl	<0.1	70.5	24.3	5.0	162,002	1.41

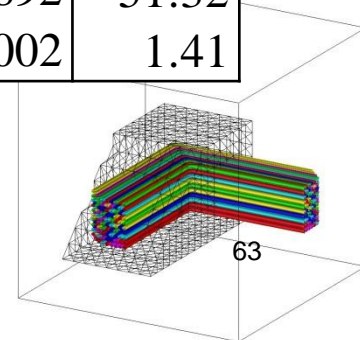

Experiment: Integrators Impact Time

Model Name	Alg	Total Boxes	Integrators (% of total boxes)				Time (sec)
			MC	Box	2Plane	BunCyl	
cPiped100	MC	1	100.0	-	-	-	790.28
tol: $\pm 1.1e-04$	+Sdiv&Box	62,392,744	45.2	54.8	-	-	63.96
vol: 0.0731920	+2 Plane	48,958,575	45.6	54.2	<0.1	-	51.32
	+BunCyl	482,756	16.8	49.6	11.8	3.3	1.41

Model Name	Alg	Integrators (% of total vol)				Total Samples	Time (sec)
		MC	Box	2Plane	BunCyl		
cPiped100	MC	100.0	-	-	-	1,410,065,909	790.28
tol: $\pm 1.1e-04$	+Sdiv&Box	0.3	99.7	-	-	56,352,288	63.96
vol: 0.0731920	+2 Plane	0.3	75.3	24.4	-	44,694,892	51.32
	+BunCyl	<0.1	70.5	24.3	5.0	162,002	1.41

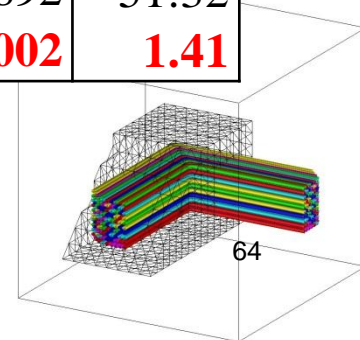

Experiment: Larger Model

Model Name	Alg	Integrators (% of total vol)				Total Samples	Time (sec)
		MC	Box	2Plane	BunCyl		
cPiped10000	MC	-	-	-	-	-	>12h*
tol: $\pm 1.1e-04$	+Sdiv&Box	1.6	98.4	-	-	279,088,846	358.09
vol: 0.0767715	+2 Plane	1.6	74.0	24.4	-	267,848,220	348.25
	+BunCyl	<0.1	70.5	24.3	5.1	931,534	9.43

*Halted after 12 hours. Extrapolating from other experiments, ~76 hours.

cPiped10000 defined by over 40k surfaces.



Handle Common Cases (even if complex)

Often geometric models have repetitive structure.

Use the repetition to decide how to process models more efficiently.

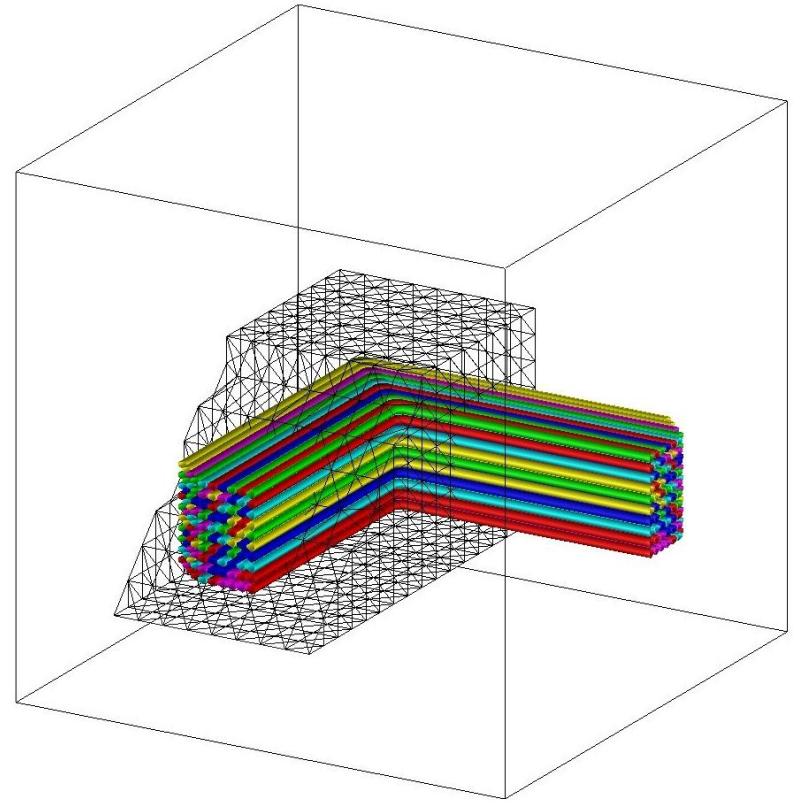

Conclusion

Basic idea: *Divide-and-conquer*.
Recursively decompose space into boxes,
determining the surfaces affecting each box,
stopping when the box is small enough
or surfaces are simple enough
that we can approximate volume accurately.

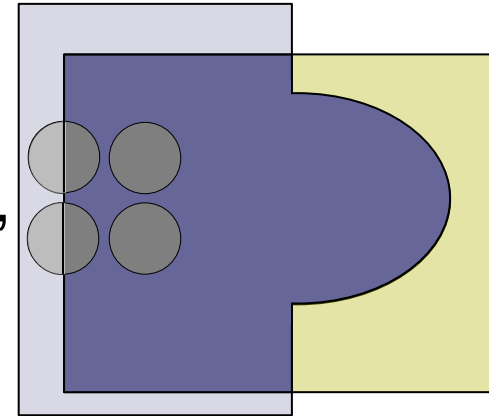

Our contribution: Framework that computes each
component's volume in multi-comp. CSG models.
Based on a minimal, extensible set of predicates that
handles any model & is very efficient on common cases.



Contact: David L. Millman · dave@cs.unc.edu

<http://cs.unc.edu/~dave>